



LG

Life's Good

Owner's Manual

IPS LED MONITOR (LED MONITOR)

Please read the safety information carefully
before using the product.

IPS LED Monitor (LED Monitor) Model List

31MU97

TABLE OF CONTENTS

3 LICENSE

4 ASSEMBLING AND PREPARING

- 4 Product Composition
- 5 Product and Button Description
- 5 - How to Use the Joystick Button
- 6 - Input Connector
- 7 Moving and Lifting the Monitor
- 8 Installing the Monitor
- 8 - Assembling the Stand
- 9 - Installing on a Table
- 9 - Adjusting the Stand Height
- 10 - Adjusting the Angle
- 10 - Tidying up Cables
- 11 - Pivot Feature
- 12 - Using the Kensington Lock
- 12 - Detaching the Stand Body
- 13 - Installing the Wall Mount Plate
- 14 - Installing on the Wall

16 USING THE MONITOR

- 16 Connecting to a PC
- 16 - HDMI Connection
- 17 - DisplayPort Connection
- 17 Connecting AV Devices
- 17 - HDMI Connection
- 18 Connecting Peripherals
- 18 - USB Cable connection - PC
- 19 - Connecting Headphones

20 INSTALLING THE LG MONITOR SOFTWARE

23 USER SETTINGS

- 23 Activating the Main Menu
- 23 - Main Menu Features
- 24 User Settings
- 24 - Menu Settings
- 25 - Ratio
- 26 - Function
- 28 - PBP
- 29 - Picture
- 31 - Color
- 32 - Settings
- 33 - Reset

34 TROUBLESHOOTING

36 PRODUCT SPECIFICATION

- 37 Factory Support Mode
(Preset Mode, HDMI/(Mini) DisplayPort PC)
- 37 HDMI Timing (Video)
- 37 Power LED

38 PROPER POSTURE

- 38 Proper Posture for Using the Monitor

LICENSE

Each model has different licenses. Visit www.lg.com for more information on the license.



The terms HDMI and HDMI High-Definition Multimedia Interface, and the HDMI logo are trademarks or registered trademarks of HDMI Licensing LLC in the United States and other countries.



VESA, VESA logo, DisplayPort compliance logo and DisplayPort compliance logo for dual-mode source devices are all registered trademarks of the Video Electronics Standards Association.



MaxxAudio and additional MAXX trademarks are trademarks and/or registered trademarks of Waves Audio Ltd.

ASSEMBLING AND PREPARING

Product Composition

Please check whether all the components are included in the box before using the product. If there are any missing components, contact the retailer where you purchased the product. Note that the product and related components may look different from those shown here.

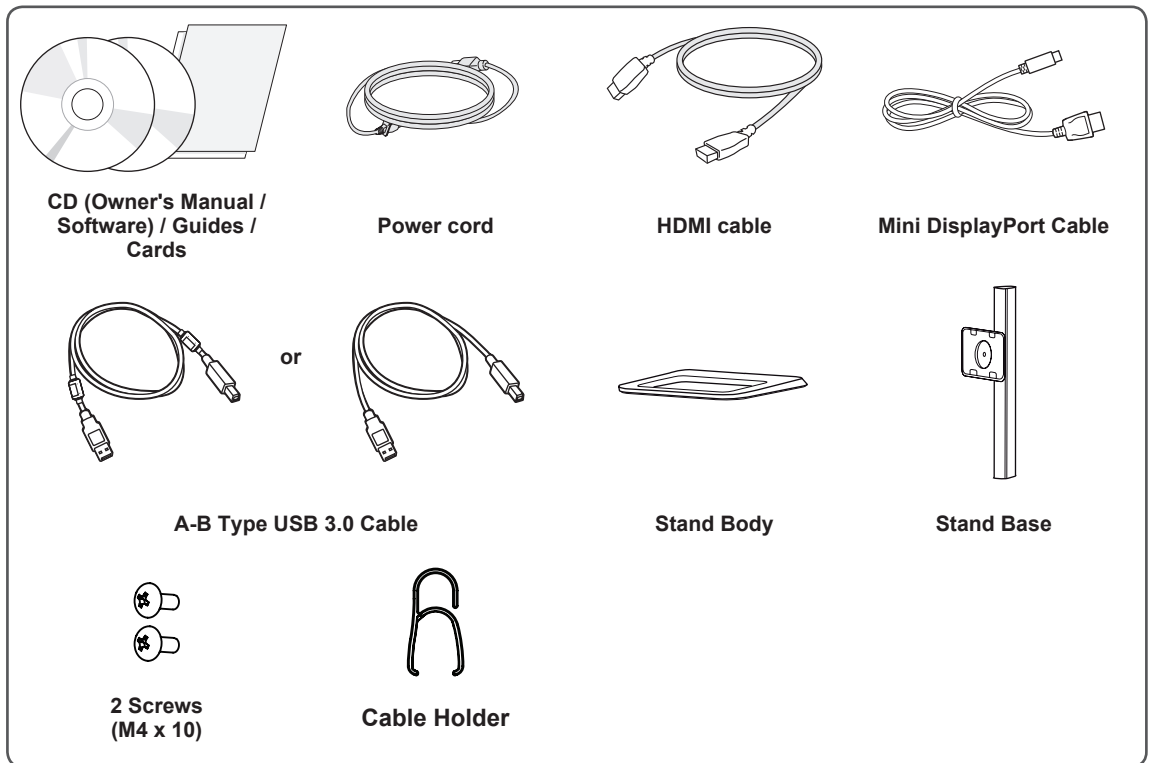

CAUTION

- Always use genuine LG components to ensure safety and product performance.
- The product warranty will not cover damage or injury caused by the use of unauthorized components.
- It is recommend that use the supplied components.
- If you use generic cables not certified by LG, the screen may not display or there may be image noises.



NOTE

- The components may look different from those illustrated here.
- Without prior notice, all product information and specifications contained in this manual are subject to change to improve the performance of the product.
- To purchase optional accessories, visit an electronics store or an online shopping site, or contact the retailer from which you purchased the product.
- The power cord provided may differ depending upon the region.

Product and Button Description

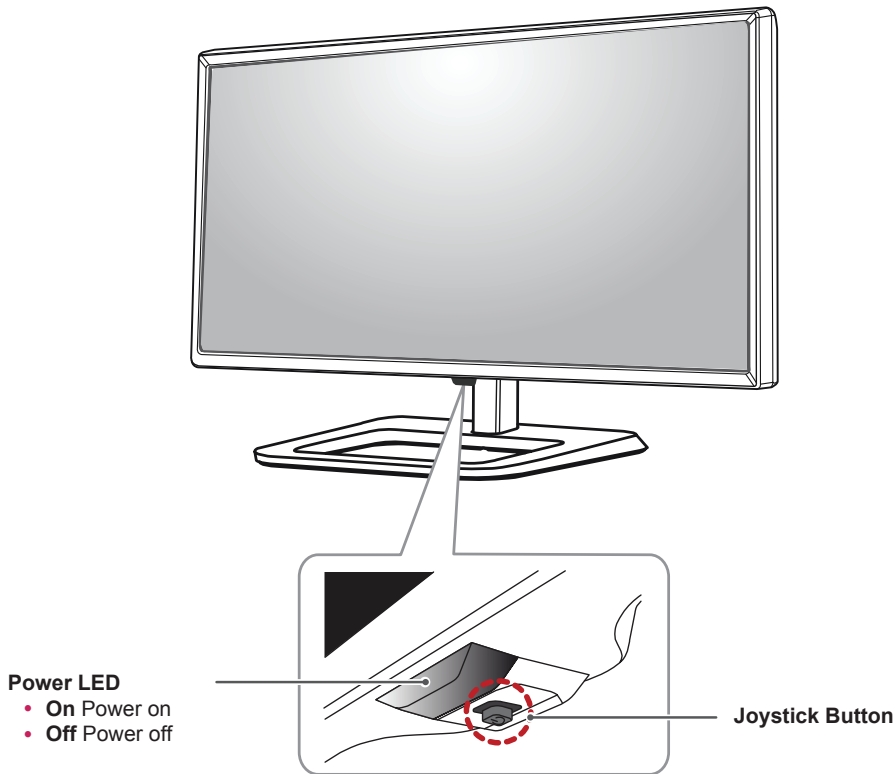

How to Use the Joystick Button

You can easily control the functions of the monitor by pressing the joystick button or moving it left/right with your finger.

Basic Functions

| | | | |
|--|--|-----------------------|-----------------------------------------------------------------------------------|
| | | Power on | Press the joystick button once with your finger to turn on the monitor. |
| | | Power off | Press and hold the joystick button once with your finger to turn off the monitor. |
| | | Volume Control | You can control the volume by moving the joystick button left/right. |



NOTE

- The joystick button is located at the bottom of the monitor.
- Before turning on the monitor, please make sure that the switch on the rear side of product is On.

Input Connector

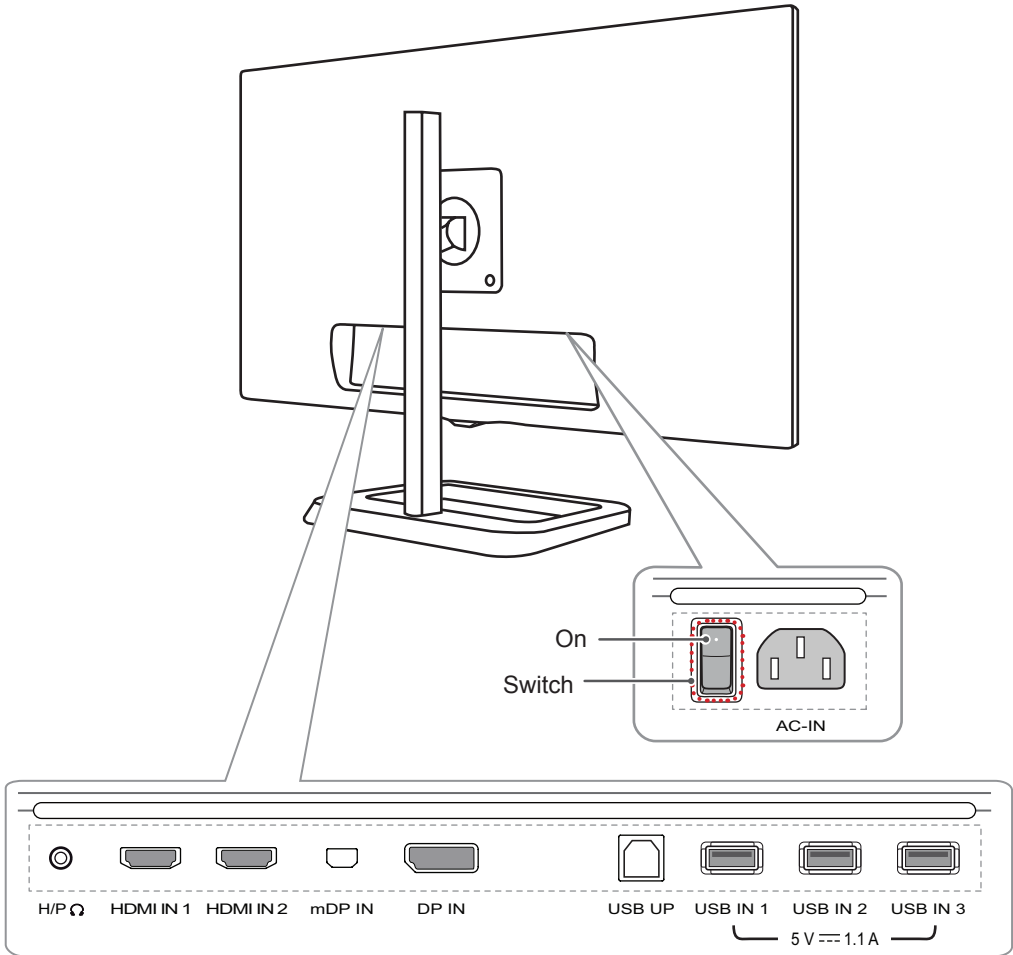

Moving and Lifting the Monitor

When moving or lifting the monitor, follow these instructions to prevent the monitor from being scratched or damaged and to ensure safe transportation, regardless of its shape or size.

- Place the monitor in the original box or packing material before attempting to move it.
- Before moving or lifting the monitor, disconnect the power cord and all other cables.
- Hold the bottom and side of the monitor frame firmly. Do not hold the panel itself.

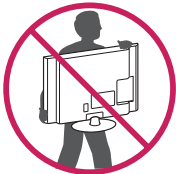
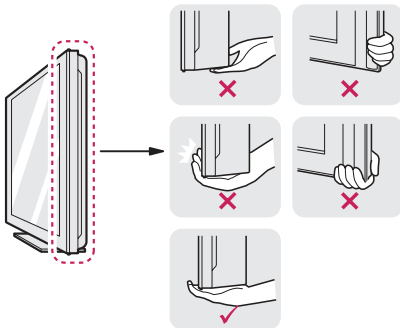

- When holding the monitor, the screen should face toward you to prevent it from being scratched.
- When transporting the monitor, do not expose the monitor to shock or excessive vibration.

- When moving the monitor, keep it upright and never turn the monitor on its side or tilt it sideways.



CAUTION

- Avoid touching the monitor screen as much as possible.
 - This may result in damage to the screen or some of the pixels used to create images.

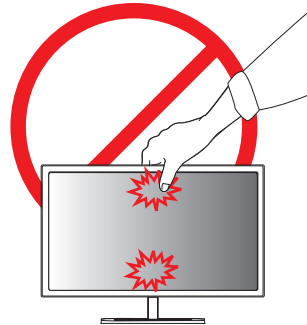

- If you use the monitor panel without the stand base, its joystick button may cause the monitor to become unstable and fall, resulting in damage to the monitor or human injury. In addition, this may cause the joystick button to malfunction.

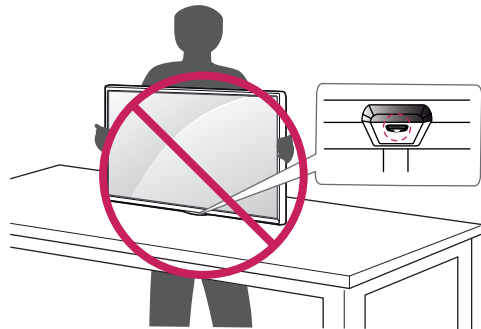

Installing the Monitor

Assembling the Stand

1

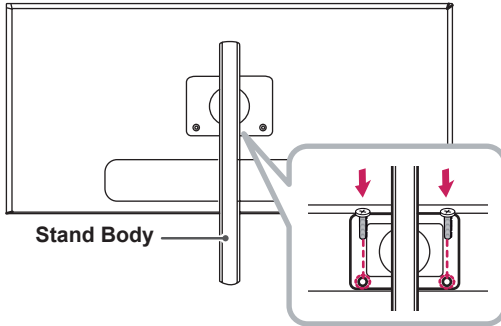

2

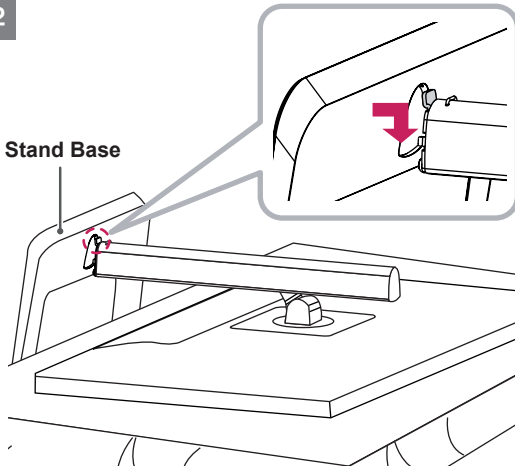

3

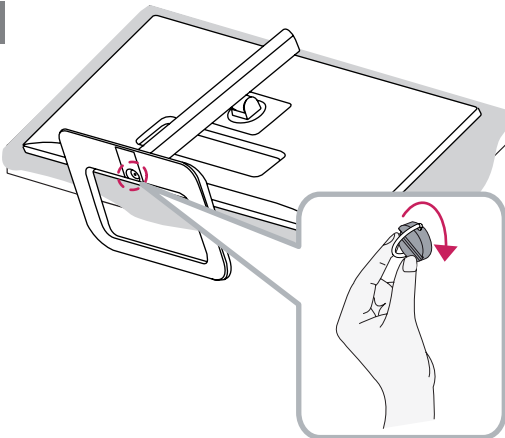

CAUTION

- To protect the screen from scratches, cover the surface with a soft cloth.
- Illustrations in this document represent typical procedures, so they may look different from the actual product.
- When tightening the screws after mounting the stand base onto the stand hinge, be sure to hold the stand base with your hand. Otherwise, the product may fall, causing personal injury or damage to the product.
- Applying excessive force when tightening screws may cause damage to the monitor. Damage caused in this way will not be covered by the product warranty.
- Do not carry the monitor upside down by just holding the base. This may cause the monitor to fall off the stand and could result in personal injury.
- When lifting or moving the monitor, do not touch the monitor screen. The force applied to the monitor screen may cause damage to it.



NOTE

- You can disassemble the stand in the reverse order of the assembly.

Installing on a Table

- 1 Lift the monitor and place it on the table in an upright position. Place the monitor at least 10 cm away from the wall to ensure sufficient ventilation.

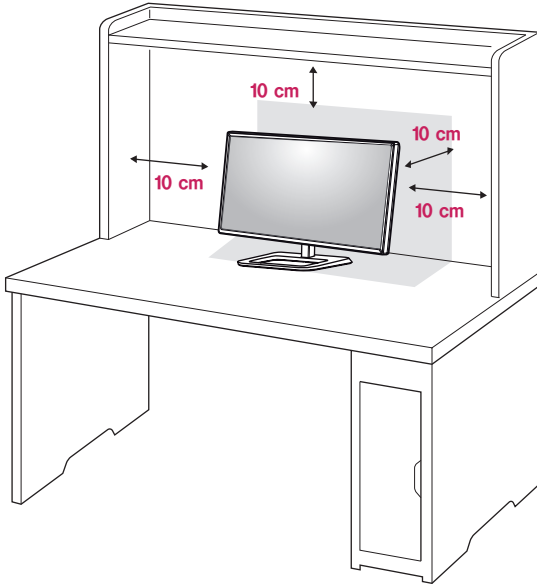

- 2 Connect the power cord to the product before connecting it to the wall outlet.

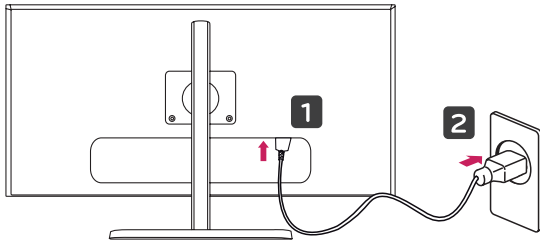

- 3 Press the joystick button on the bottom of the monitor to turn on the monitor.



CAUTION

- Unplug the power cord before moving or installing the monitor. There is risk of electric shock.

Adjusting the Stand Height

- 1 Place the monitor mounted on the stand base in an upright position.
- 2 Push the Head downward and pull out the Locking Pin.

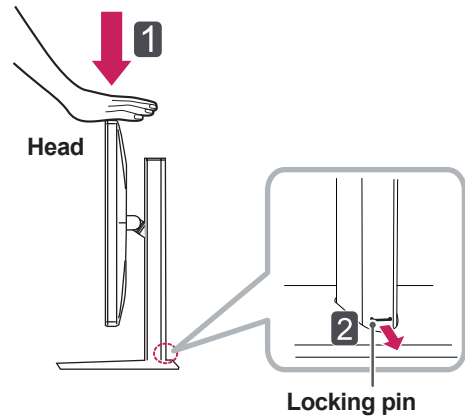

- 3 Handle the monitor with both hands for safety.

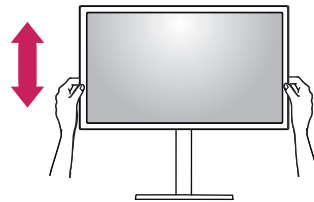

- 4 The height can be adjusted up to 140.0 mm.

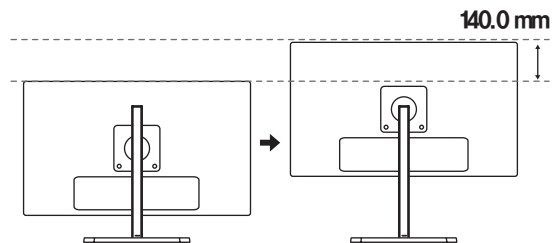

**CAUTION**

- Once the pin is removed, it is not necessary to re-insert it to adjust the height.

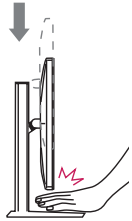
**WARNING**

- Do not put your fingers or hand between the screen and the base (chassis) when adjusting the screen's height.

Adjusting the Angle

- 1 Place the monitor mounted on the stand base in an upright position.
- 2 Adjust the angle of the screen. The angle of the screen can be adjusted forward or backward from -5° to 15° for a comfortable viewing experience.

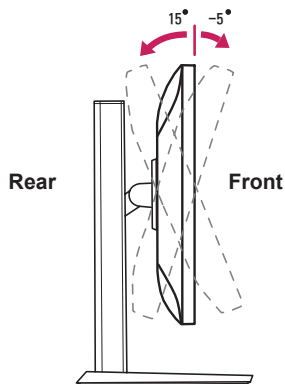
**WARNING**

- When you adjust the angle, do not hold the stand as shown on the following illustration. You may injure your fingers.

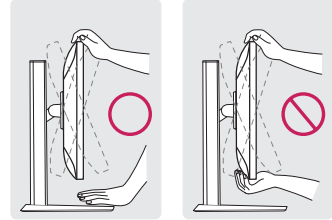

- Be careful not to touch or press the screen area when adjusting the angle of the monitor.

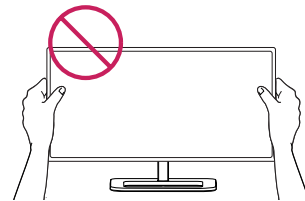
**Tidying up Cables**

Arrange the cables using the cable holder as shown in the illustration.

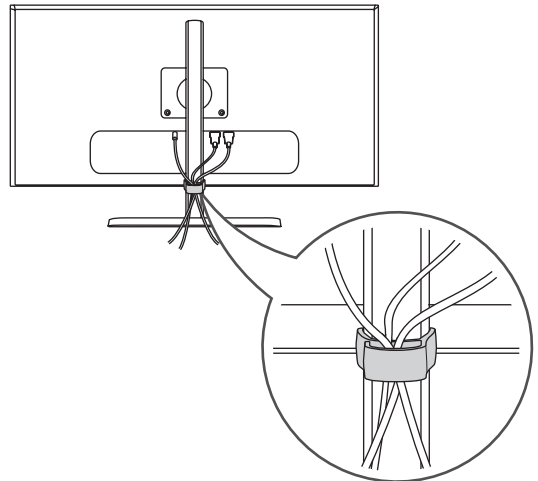

Pivot Feature

The pivot feature allows the monitor to rotate 90° clockwise.

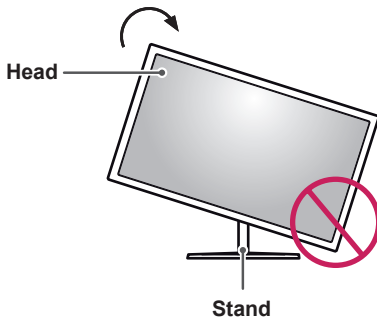

! WARNING

- To avoid scratching the stand base, make sure that when rotating the monitor using the pivot feature, the stand does not make contact with the monitor.

- 1 Raise the monitor to the maximum height.

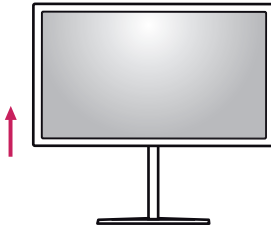

- 2 Adjust the angle of the monitor in the direction of the arrow as shown in the figure.

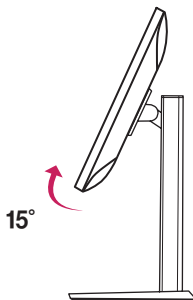

- 3 Rotate the monitor clockwise as shown in the figure.

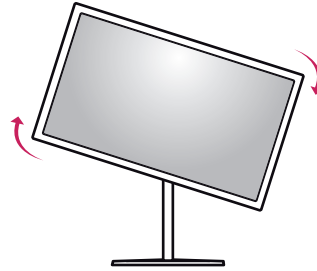

- 4 Complete the installation by rotating the monitor 90° as shown below.



! WARNING

- Take care when rotating the monitor if the cable is connected.
- To avoid injury when rotating the display, do not place your fingers between the display and the stand base.

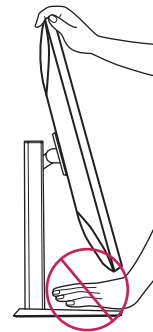

Using the Kensington Lock

The Kensington security system connector is located at the back of the Monitor set. For more information on installation and usage, refer to the Kensington lock owner's manual or visit the website at <http://www.kensington.com>.

Connect the monitor to a table using the Kensington security system cable.

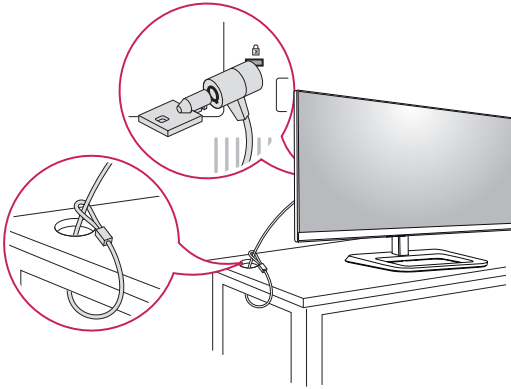

NOTE

- The Kensington security system is optional. You can obtain optional accessories from most electronics stores.

Detaching the Stand Body

- 1 Place the monitor's screen face down. To protect the screen from scratches, cover the surface with a soft cloth.
- 2 Using a screwdriver, remove the 2 screws and detach the stand from the monitor.

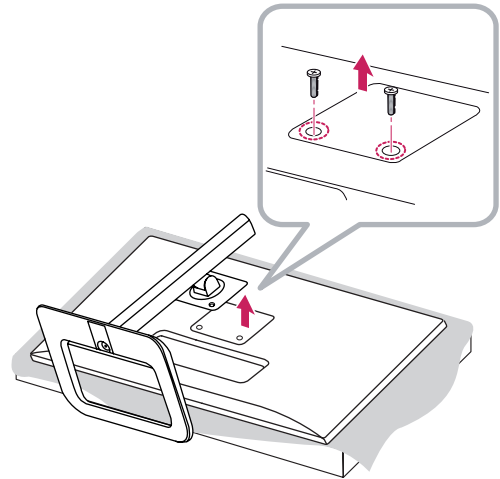

Installing the Wall Mount Plate

This monitor meets the specifications for the wall mount plate or other compatible devices.

- 1 Place the screen face down. To protect the screen from scratches, cover the surface with a soft cloth.
- 2 Using a screwdriver, remove the 2 screws and detach the stand from the monitor.

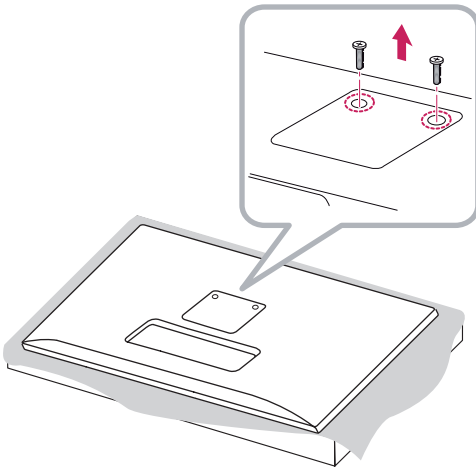

- 3 Place the wall mount plate onto the monitor and align it with the screw holes.
- 4 Tighten the four screws to fix the plate to the monitor using a screwdriver.

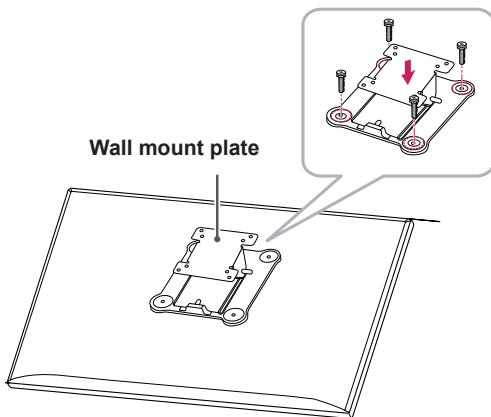

! NOTE

- The wall mount plate is sold separately.
- For more information on installation, refer to the wall mount plate's installation guide.
- Be careful not to apply too much force while mounting the wall mount plate as it may cause damage to the screen.

Installing on the Wall

Install the monitor at least 10 cm away from the wall and leave about 10 cm of space at each side of the monitor to ensure sufficient ventilation. Detailed installation instructions can be obtained from your local retail store. Alternatively, please refer to the manual for how to install and set up a tilting wall mounting bracket.

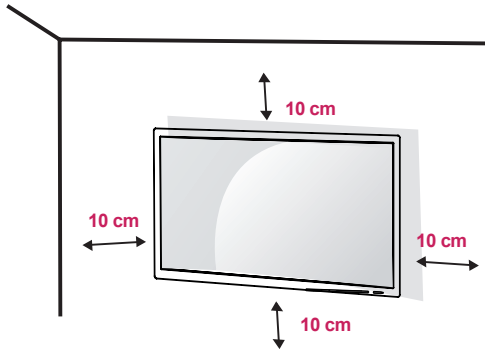

To install the monitor to a wall, attach a wall mounting bracket (optional) to the back of the monitor. Make sure that the wall mounting bracket is securely fixed to the monitor and to the wall.

- 1 If you use screws longer than the standard length, it may damage the inside of the product.
- 2 A non-VESA standard screw may damage the product and cause the monitor to fall. LG Electronics is not liable for any accidents relating to the use of non-standard screws.

- Wall Mount (A x B)

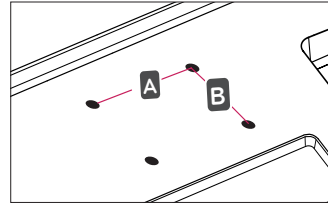

NOTE

- Use the screws specified by VESA standards.
- The wall mount kit includes the installation guide and all necessary parts.
- The wall mounting bracket is optional. You can obtain optional accessories from your local dealer.
- The length of the screw may differ for each wall mounting bracket. Be sure to use the proper length.
- For more information, please refer to the user manual for the wall mounting bracket.

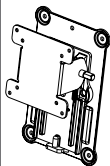
| | |
|------------------------------------|----------------------------------------------------------------------------------------------|
| Wall Mount (A x B) | 100 x 100 |
| Stand Screw | M4 x 10 mm |
| Required Screws | 4 |
| Wall Mount Plate (Optional) | RW120  |

**CAUTION**

- Unplug the power cord before moving or installing the monitor to avoid electric shock.
- Installing the monitor on the ceiling or on a slanted wall may result in the monitor falling off, which could lead to injury. Use an authorized LG wall mount and contact the local dealer or qualified personnel.
- Applying excessive force when tightening screws may cause damage to the monitor. Damage caused in this way will not be covered by the product warranty.
- To prevent injury, this apparatus must be securely attached to the wall in accordance with the installation instructions. (This only pertains to Australia and New Zealand.)
- Use the wall mounting bracket and screws that conform to VESA standards. Damage caused by the use or misuse of inappropriate components will not be covered by the product warranty.
- When measured from the back of the monitor, the length of each installed screw must be 8 mm or less.

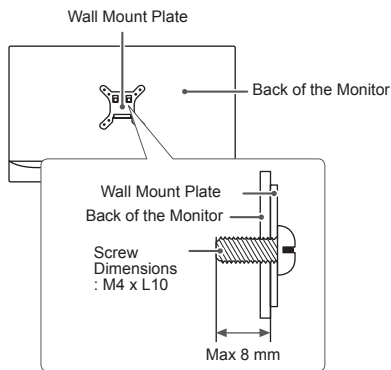

USING THE MONITOR

Press the joystick button, go to Menu → Easy control → Input, and then select the input option.



CAUTION

- Do not press the screen for a prolonged time. This may cause image distortion.
- Do not display a still image on the screen for a prolonged time. This may cause image retention. Use a screensaver if possible.



NOTE

- When connecting the power cord to the outlet, use a grounded (3-hole) power strip or a grounded power outlet.
- The monitor may flicker when turned on in an area where the temperature is low. This is normal.
- Sometimes red, green or blue spots may appear on the screen. This is normal.

Connecting to a PC

- This monitor supports the *Plug and Play feature.

* Plug and Play: A feature that allows you to add a device to your computer without having to reconfigure anything or install any manual drivers.

HDMI Connection

Transmits digital video and audio signals from your PC to the monitor. Connect your PC to the monitor using the HDMI cable as shown in the illustration below.

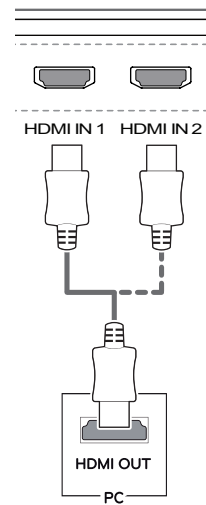

CAUTION

- Make sure to use the supplied HDMI cable of the product. Otherwise, this may cause the device to malfunction.
- Connecting your PC to the monitor using the HDMI cable may cause device compatibility issues.
- Using a DVI to HDMI / DP(DisplayPort) to HDMI cable may cause compatibility issues.

(Mini) DisplayPort Connection

Transmits digital video and audio signals from your PC to the monitor. Connect the monitor to your PC using the displayport cable as shown in the illustration below:

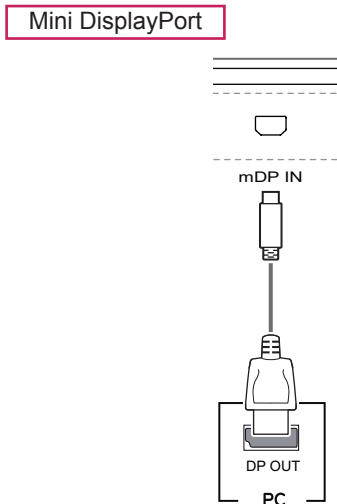
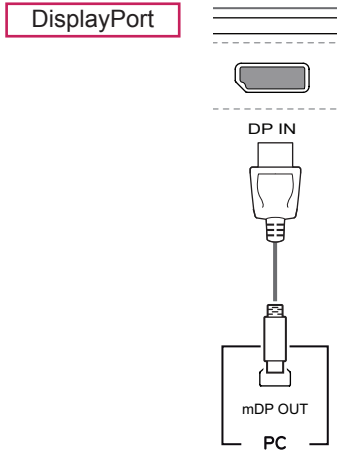

Connecting AV Devices

HDMI Connection

HDMI transmits digital video and audio signals from your AV device to the monitor. Connect your AV device to the monitor using the HDMI cable as shown in the illustration below.

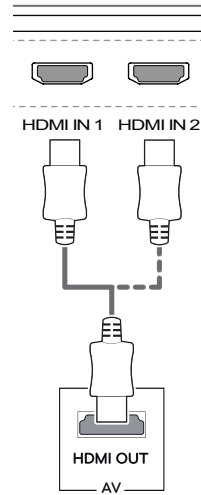

! **NOTE**

- Make sure to use the supplied HDMI cable of the product. Otherwise, this may cause the device to malfunction.
- Using a DVI to HDMI / DP(DisplayPort) to HDMI cable may cause compatibility issues.

! **NOTE**

- There may be no video or audio output depending on the DP (DisplayPort) version of the PC.
- Make sure to use the supplied Mini DisplayPort cable of the product. Otherwise, this may cause the device to malfunction.
- If you use generic cables not certified by LG, the screen may not display or there may be image noises.

Connecting Peripherals

USB Cable connection - PC

The USB port on the product functions as a USB hub.

NOTE

- Make sure to install the most recent Windows OS service pack before using the product.
- Peripheral devices are sold separately.
- A keyboard, mouse, or USB device can be connected to the USB port.



CAUTION

Cautions When Using a USB Device

- A USB device with an automatic recognition program installed, or that uses its own driver, may not be recognized.
- Some USB devices may not be supported or may not work properly.
- It is recommended to use a USB hub or hard disk drive with power supplied. (If the power supply is not adequate, the USB device may not be recognized properly.)

To use USB 3.0, connect the A-B type USB 3.0 cable of the product to the PC.

Peripheral devices connected to the USB IN port can be controlled from the PC.

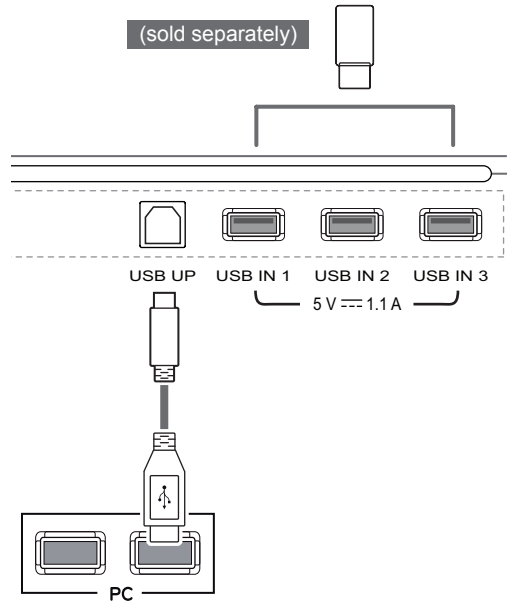

Connecting Headphones

Connect peripherals to the monitor via the headphones port. Connect as illustrated.

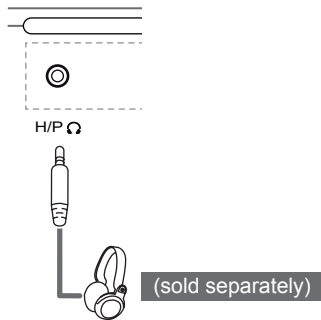

NOTE

- Peripheral devices are sold separately.
- If you use Angled earphones, it may cause a problem with connecting another external device to the monitor. Therefore, it is recommended to use Straight earphones.



Angled



Straight

- Depending on the audio settings of the PC and external device, headphones and speaker functions may be limited.

INSTALLING THE LG MONITOR SOFTWARE

Insert the software CD included in the product packaging into your PC's CD drive and install the LG Monitor Software.

The installation screen images are for reference only. The actual installation screen images may vary depending on the model.

- 1 Set up Internet Explorer as the default web browser.



- 2 Click **LG Monitor Software** on the CD's main screen. When the file download window appears, click **Run**. (Although the screen below may differ depending on your operating system or Internet Explorer version, the installation methods are the same.)



CAUTION

- Windows 7 must be updated to Service Pack 1 or higher.

- 3 Follow the instructions to proceed with the installation.

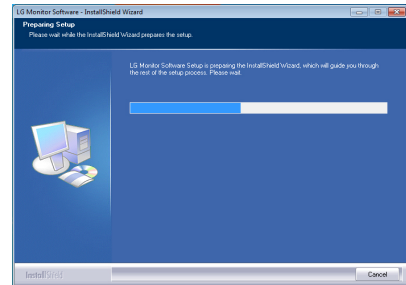

- 4 Check the **I accept the terms of the agreement** checkbox on the License Agreement screen and then click the **Next** button.

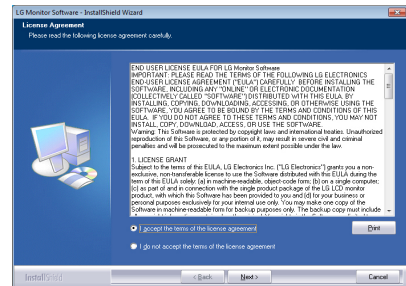

- 5 Select the program that you want to install.

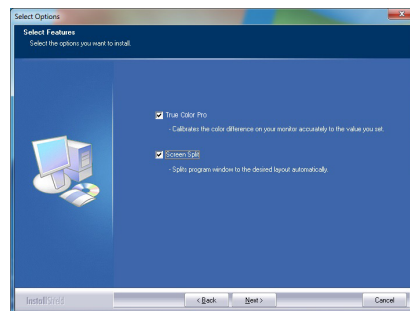

NOTE

- **Screen Split** This program automatically splits the program window as desired.
- **True Color Pro** This program calibrates the precise color output of the monitor to suit your needs.

6 The LG Monitor Software starts the installation as shown below:

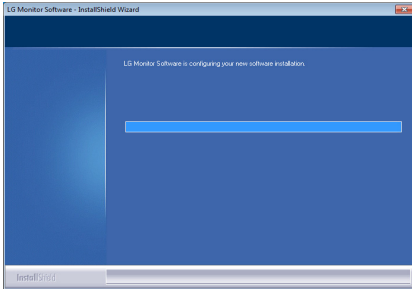

7 If the TUSB3410 driver has not been installed, the driver will be installed automatically. Select **Install this driver software anyway (I)** if the Windows security message is displayed as below.

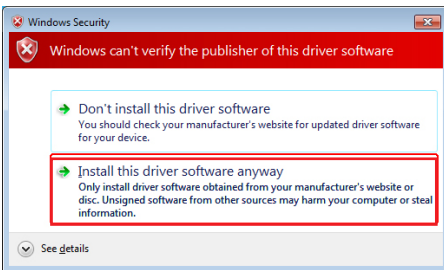
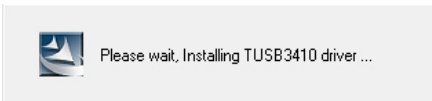

8 The program you selected on the Select Features page will install automatically.

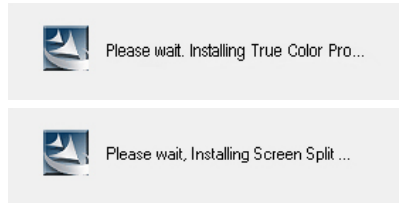

9 When the installation is complete, restart your system.

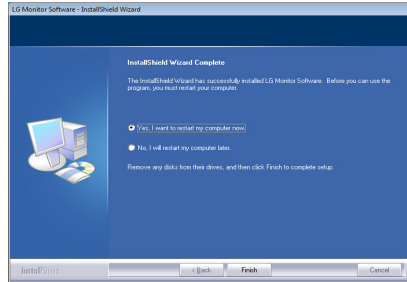

NOTE

- When you run the True Color Pro software, the True Color Pro icon [🌈] appears in the system tray at the right bottom of the PC screen.

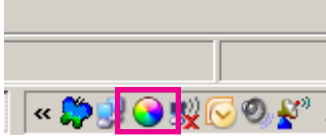

- Right-click the True Color Pro icon and select Start Program to start the program.

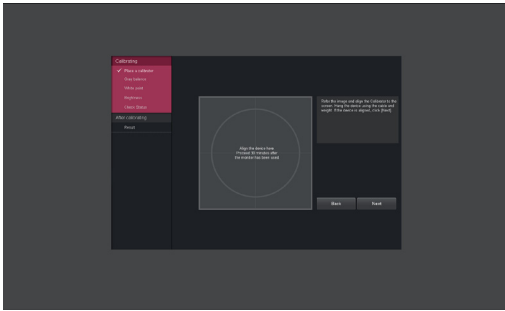
**CAUTION**

- Once you have completed the monitor calibration with the True Color Pro software, remove the calibrator from the monitor and store it at room temperature away from direct sunlight or put it in the box.
 - If the calibrator's measuring part is exposed to direct sunlight for a long time, this may cause damage to the calibrator.
 - Do not store it in an environment with too low/high temperature and high humidity.
- If any third-party calibration application is already installed on your PC, the image quality may be affected by a conflict between the two applications. For the best performance, it is recommended to uninstall the other calibration application.

NOTE

- To use the True Color Pro function, you must purchase the supported calibrator.
- For details on supported calibrators and graphic cards, see the True Color Pro user guide.
- If you have changed the input port, it is recommended that you calibrate the monitor's picture quality again.

NOTE

- When you run Screen Split, the Screen Split icon [🖥️] appears in the system tray at the bottom right of the PC screen.



- Right-click the Screen Split icon and select the desired layout.

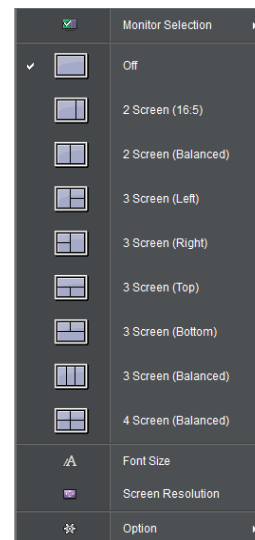

USER SETTINGS

Activating the Main Menu

- 1 Press the joystick button on the bottom of the monitor.
- 2 Move the joystick up/down (▲/▼) and left/right(◀/▶) to set the options.
- 3 Press the joystick button once more to exit the main menu.

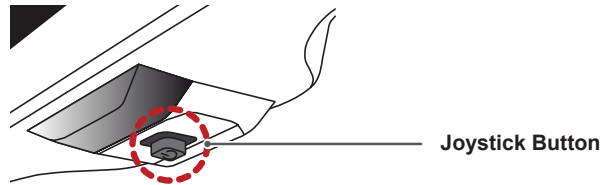

| Button | Menu Status | Description |
|--------|-----------------------------|-------------------------------------------------------------------------------------------------------------------------------------------------------------|
| | Main menu disabled | Enables the main menu. |
| | Main menu enabled | Exits the main menu. (Holding down the button to turn off the monitor: You can turn off the monitor this way at any time, including when the OSD is on.) |
| | ◀ Main menu disabled | Adjusts the monitor volume level. |
| | ◀ Main menu enabled | Enters the menu features. |
| | ▶ Main menu disabled | Adjusts the monitor volume level. |
| | ▶ Main menu enabled | Enters the PBP feature. |
| | ▲ Main menu disabled | Enables the main menu. |
| | ▲ Main menu enabled | Enters the Picture Mode feature. |
| | ▼ Main menu disabled | Enables the main menu. |
| | ▼ Main menu enabled | Turns off the monitor. |

Main Menu Features

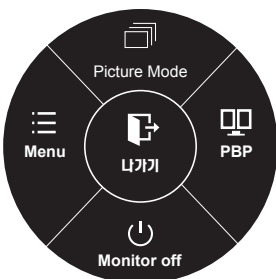

| Main Menu | Description |
|---------------------|---------------------------------------------------------|
| Menu | Configures the screen settings. |
| Picture Mode | Optimizes the screen for picture mode. |
| PBP | Displays the screens of two input modes on one monitor. |
| Monitor off | Turns off the monitor. |
| Exit | Exits the main menu. |

Ⓞ Long press: Monitor off

User Settings

Menu Settings

- 1 To view the **OSD menu**, press the **joystick button** at the bottom of the monitor and then enter the **Menu**.
- 2 Configure the options by moving the joystick up/down/left/right.
- 3 To return to the upper menu or set other menu items, move the joystick to ◀ or pressing (⊙ / OK) it.
- 4 If you want to exit the OSD menu, move the joystick to ◀ until you exit.
 - When you enter the menu, instructions on how to use the button will appear in the bottom right corner of the screen.



Easy control



Function



PBP



Screen



Settings



Reset

Each option is described below.

| Menu | | Description |
|--------------|-----------------------------------------------------------------------------------------------------------------------------------------------------------------------------------------------------------------------|---------------------------------------------------------------------|
| Easy control | Brightness | Adjusts the color contrast and brightness of the screen. |
| | Contrast | |
| | Volume | Adjusts the volume level. |
| | <div style="border: 1px solid black; padding: 5px;"> <p>NOTE</p> <ul style="list-style-type: none"> • You can adjust Mute/ Unmute by moving the joystick button to ▼ in the Volume menu. </div> | |
| | Input | Selects the input mode. |
| Ratio | Adjusts the aspect ratio of the screen. | |
| Function | Adjusts MaxxAudio, Picture Mode, Dual Color Space and SUPER ENERGY SAVING. | |
| PBP | PBP | Displays the screens of two input modes on one monitor. |
| Screen | Picture | Adjusts the Sharpness, Black level and Response Time of the screen. |
| | Color | Adjusts Gamma, Color Temperature, Red, Green, Blue and Six Color. |
| Settings | Adjusts Language, Power LED, Automatic Standby, DisplayPort 1.2 and OSD Lock. | |
| Reset | Restores the default settings. | |
| ◀ | Exit | Exits the OSD menu. |

Ratio

- 1 To view the **OSD menu**, press the **joystick button** at the bottom of the monitor and then enter the **Menu**.
- 2 Go to **Easy control > Ratio** by moving the joystick.
- 3 Configure the options following the instructions that appear in the bottom right corner.
- 4 To return to the upper menu or set other menu items, move the joystick to ◀ or pressing (⊙ / OK) it.
- 5 If you want to exit the OSD menu, move the joystick to ◀ until you exit.

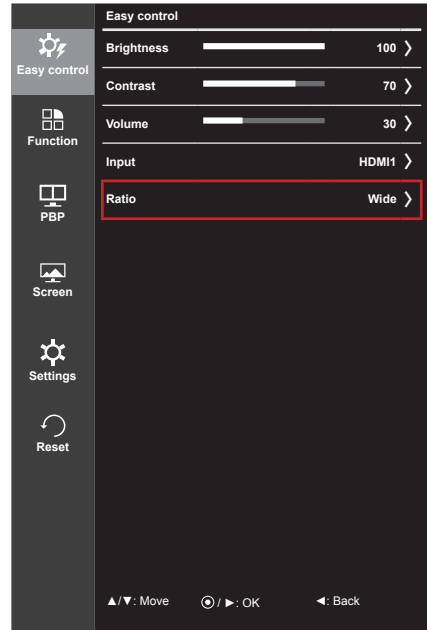

Each option is described below.

| Menu > Easy control > Ratio | Description |
|-----------------------------|-------------------------------------------------------------------------|
| Wide | Displays the video in widescreen, regardless of the video signal input. |
| Original | Displays video according to the aspect ratio of the video signal input. |
| 1:1 | The aspect ratio is not adjusted from the original. |

NOTE

- The display may look the same for Wide, Original, and 1:1 options at the recommended resolution.
 - Recommended resolution for mDP (Mini DisplayPort) and DP (DisplayPort) : 4096 x 2160
 - Recommended resolution for HDMI : 3840 x 2160
- The ratio is disabled in the interlaced signal.

Function

- 1 To view the **OSD menu**, press the **joystick button** at the bottom of the monitor and then enter the **Menu**.
- 2 Go to **Function** by moving the joystick.
- 3 Configure the options following the instructions that appear in the bottom right corner.
- 4 To return to the upper menu or set other menu items, move the joystick to ◀ or pressing (⊙ / OK) it.
- 5 If you want to exit the OSD menu, move the joystick to ◀ until you exit.

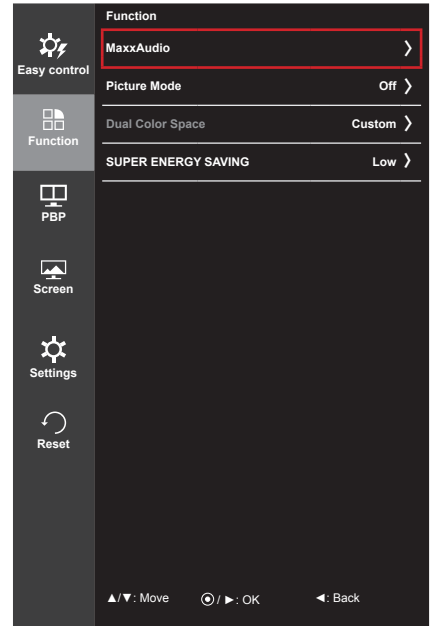

Each option is described below.

| Menu > Function | | Description | |
|-------------------------------|-----------------------------------------------------|----------------------------------------------------|-------------------------------------------------------------------------------------------------------------------------------------------|
| MaxxAudio Features (Settings) | MaxxAudio Features (Settings) | On | MaxxAudio® by Waves, recipient of a Technical GRAMMY Award® is a suite of studio-quality sound tools for a superior listening experience. |
| | | Off | Disables the MaxxAudio function. |
| | Maxx Sound Equalizer | The user can set the sound quality manually. | |
| | | MaxxBass | Adjusts bass. |
| | | MaxxTreble | Adjusts treble. |
| | | MaxxDialog | Adjusts audio. |
| | | Maxx3D | Adjusts the three-dimensional effect of the sound. |
| | Reset | Returns the sound quality to the default settings. | |
| Midnight Mode | Lets you enjoy rich and full sound at a low volume. | | |

| Menu > Function | Description | |
|----------------------------|----------------------|--------------------------------------------------------------------------------------------------------------------------------------------------------------------------------------------------------------------------------------------------------------------------------------------------------------------------------------------------------------------------|
| Picture Mode | Custom | Allows the user to adjust each element. The color mode of the main menu can be adjusted. |
| | sRGB | A standard RGB color space for the monitor and printer. |
| | AdobeRGB | A much larger color space than sRGB. This option is suitable for printing pictures. |
| | DCM Sim. | Optimizes the screen for viewing X-ray images. You can brighten the screen in the OSD menu. NOTE <ul style="list-style-type: none"> This product has been approved as an IT device and not as a medical device. It is intended for office use only. (It may be used for education and reference purposes but not for medical diagnosis.) |
| | DCI-P3 Sim. | Suitable for watching digital videos. |
| | Reader | Optimizes the screen for viewing documents. You can brighten the screen in the OSD menu. |
| | Calibration 1 | Adjusts to the last calibrated screen. |
| | Calibration 2 | Adjusts to the previously calibrated screen. |
| Dual Color Space | Off | Disables the Dual Color Space function. |
| | sRGB | Sets the sRGB Picture Mode on the left of the screen. |
| | AdobeRGB | Sets the Adobe Picture Mode on the left of the screen. |
| | Calibration 1 | Sets the Calibration 1 Picture Mode on the left of the screen. |
| | Calibration 2 | Sets the Calibration 2 Picture Mode on the left of the screen. |
| SUPER ENERGY SAVING | High | Saves energy using the high-efficiency SUPER ENERGY SAVING feature. |
| | Low | Saves energy using the low-efficiency SUPER ENERGY SAVING feature. |
| | Off | Disables the SUPER ENERGY SAVING feature. |

PBP

- 1 To view the **OSD menu**, press the **joystick button** at the bottom of the monitor and then enter the **Menu**.
- 2 Go to **PBP** by moving the joystick.
- 3 Configure the options following the instructions that appear in the bottom right corner.
- 4 To return to the upper menu or set other menu items, move the joystick to ◀ or pressing (⊙ / OK) it.
- 5 If you want to exit the OSD menu, move the joystick to ◀ until you exit.

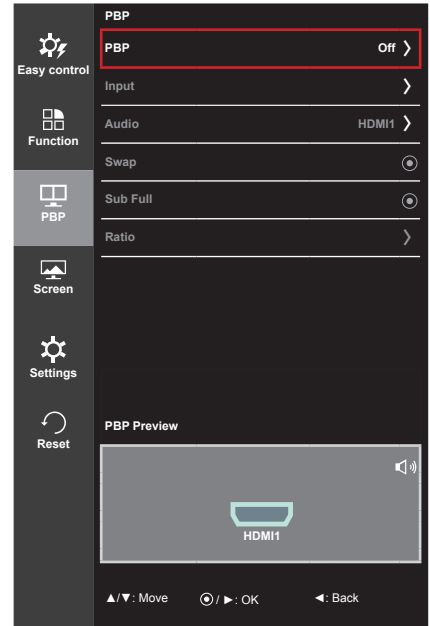

Each option is described below.

| Menu > PBP | Description | | | | |
|---------------------------|-------------------------------------------------------------|-------------------------------------------------------------------------------------|-------------------------------------------------------------------------------------|---------------|---------------------------|
| PBP | Displays the screens of two input modes on one monitor. | | | | |
| | PBP Connection | | Sub Screen (Right) | | |
| | Main Screen (Left) | HDMI 1 | HDMI 1 | HDMI 2 | (Mini) DisplayPort |
| | | HDMI 2 | - | ○ | X |
| (Mini) DisplayPort | | ○ | - | X | |
| Input | Main | Selects the video signal input of the main screen. | | | |
| | Sub | Selects the video signal input of the sub screen. | | | |
| Audio | Changes the audio output in PBP mode. | | | | |
| Swap | Toggles between the main screen and sub screen in PBP mode. | | | | |
| Sub Full | Converts the sub screen in PBP mode to wide screen. | | | | |
| Ratio | Adjusts the aspect ratio of the main screen or sub screen. | | | | |
| | Main | Wide | Displays the video to fit the PBP screen, regardless of the video signal input. | | |
| | | Original | Displays the video in the aspect ratio of the video signal input on the PBP screen. | | |
| | Sub | Wide | Displays the video to fit the PBP screen, regardless of the video signal input. | | |
| Original | | Displays the video in the aspect ratio of the video signal input on the PBP screen. | | | |



NOTE

- When the PBP mode is Off, Input, Audio, Swap, Sub Full, and Ratio menus become disabled. The Main/Sub options for Ratio become disabled if there is no signal.

Picture

- 1 To view the **OSD menu**, press the **joystick button** at the bottom of the monitor and then enter the **Menu**.
- 2 Go to **Screen > Picture** by moving the joystick.
- 3 Configure the options following the instructions that appear in the bottom right corner.
- 4 To return to the upper menu or set other menu items, move the joystick to ◀ or pressing (⊙ / OK) it.
- 5 If you want to exit the OSD menu, move the joystick to ◀ until you exit.

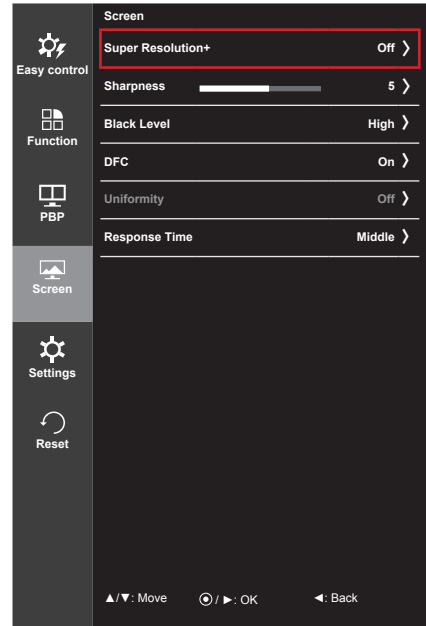

Each option is described below.

| Menu > Screen > Picture | Description | | | |
|--------------------------|---------------------------------------------------------------------------------------------------------------------------------------------------------------------------------------------------------------------------------------------------------------------------------------------------------------------------------------------------------------------------------------------------------------------------------------------------------------------------------------------------------------------------------------------------------------------------------------------------------------------------------|-------------|------------------------------------------|------------|
| SUPER RESOLUTION+ | <p>With the picture improvement technology that minimizes the degradation of the picture quality due to enlargement (e.g. blurred focus or unsharpened edges), the resolution is not compromised, even when the images are enlarged, which guarantees a clear image.</p> <div style="border: 1px solid black; padding: 5px;"> <p>NOTE</p> <ul style="list-style-type: none"> Because this is a function to increase the sharpness of low resolution pictures, it is not recommended to use the function for normal text or for desktop icons. Doing so may result in unnecessarily high sharpness. </div> | | | |
| Sharpness | Adjusts the sharpness of the screen. | | | |
| Black Level | Sets the offset level (for HDMI only). | | | |
| | <ul style="list-style-type: none"> Offset: as a reference for a video signal, this is the darkest color the monitor can display. | | | |
| | <table border="1" style="width: 100%;"> <tr> <td style="width: 15%;">High</td> <td>The picture of the screen gets brighter.</td> </tr> <tr> <td>Low</td> <td>The picture of the screen gets darker.</td> </tr> </table> | High | The picture of the screen gets brighter. | Low |
| High | The picture of the screen gets brighter. | | | |
| Low | The picture of the screen gets darker. | | | |
| DFC | Adjusts the brightness automatically according to the screen. | | | |

| Menu > Screen > Picture | Description | | | | | | | | |
|-------------------------|-------------------------------------------------------------------------------------------------------------------------------------------------------------------------------------------------------------------------------------------------------------------------------------------------------------------------------------------------------------------------------------------------------------------------------------------------------------------------------------------------------------------------------------------------------------------------------------------------------------------------------------------------------------------------------------------------------------------------------------------------------------------------------------------------------------------------------------------------------------------------------------------------------------------------------------|-------------|---------------------------------|---------------|-----------------------------------|------------|--------------------------------|------------|-----------------------------------------------------|
| Uniformity | <p data-bbox="414 218 714 247">Adjusts uniformity of the image.</p> <div data-bbox="414 266 1254 388" style="border: 1px solid black; padding: 5px;"> <p data-bbox="432 266 563 305">NOTE</p> <ul data-bbox="440 316 1232 369" style="list-style-type: none"> <li data-bbox="440 316 1232 369">• The Uniformity menu is activated only in sRGB and Adobe RGB modes. Enabling Uniformity may reduce the overall brightness of the image. </div> | | | | | | | | |
| Response Time | <p data-bbox="414 407 1249 504">Sets a response time for displayed pictures based on the speed of the screen. For a normal environment, it is recommended that you use Middle. For a fast-moving picture, it is recommended that you use high. Setting to High may cause image sticking.</p> <table border="1" data-bbox="408 508 1270 635"> <tbody> <tr> <td data-bbox="408 508 514 537">High</td> <td data-bbox="514 508 1270 537">Sets the response time to High.</td> </tr> <tr> <td data-bbox="408 537 514 566">Middle</td> <td data-bbox="514 537 1270 566">Sets the response time to Middle.</td> </tr> <tr> <td data-bbox="408 566 514 595">Low</td> <td data-bbox="514 566 1270 595">Sets the response time to Low.</td> </tr> <tr> <td data-bbox="408 595 514 635">Off</td> <td data-bbox="514 595 1270 635">Does not use the response time improvement feature.</td> </tr> </tbody> </table> | High | Sets the response time to High. | Middle | Sets the response time to Middle. | Low | Sets the response time to Low. | Off | Does not use the response time improvement feature. |
| High | Sets the response time to High. | | | | | | | | |
| Middle | Sets the response time to Middle. | | | | | | | | |
| Low | Sets the response time to Low. | | | | | | | | |
| Off | Does not use the response time improvement feature. | | | | | | | | |

Color

- 1 To view the **OSD menu**, press the **joystick button** at the bottom of the monitor and then enter the **Menu**.
- 2 Go to **Screen > Color** by moving the joystick.
- 3 Configure the options following the instructions that appear in the bottom right corner.
- 4 To return to the upper menu or set other menu items, move the joystick to ◀ or pressing (⊙ / OK) it.
- 5 If you want to exit the OSD menu, move the joystick to ◀ until you exit.

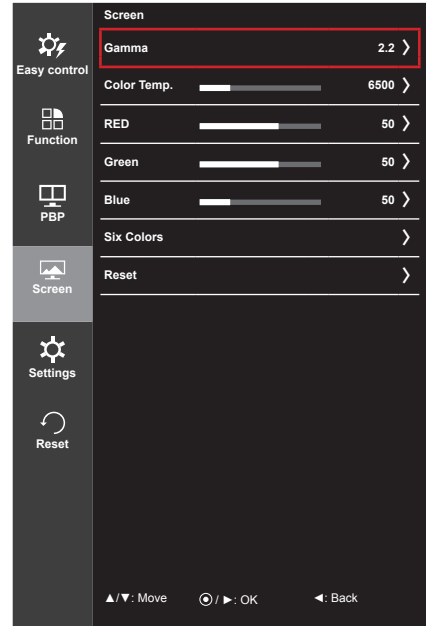

Each option is described below.

| Menu > Screen > Color | Description | |
|-----------------------|-------------------------------------------------------------------------------------------------------------------------------------------------------------------------|---------------------------------------------------------------------------------------------------------------------------------------------------------------------------------------------|
| Gamma | Gamma settings: When using the gamma 0, gamma 1 and gamma 2 monitor settings, higher gamma settings mean a brighter image is displayed and vice versa. | |
| Color Temp | Manual | Adjusts the color temperature in 500K increments. (Note that 9300K is supported instead of 9500K.) |
| | Custom | The user can adjust it to red, green, or blue by customization. |
| Red | You can customize the picture color using Red, Green and Blue colors. | |
| Green | | |
| Blue | | |
| Six Colors | Meets the user requirements for colors by adjusting the hue and saturation of the six colors (red, green, blue, cyan, magenta and yellow) and then saving the settings. | |
| | Hue | Adjusts the tone of the screen colors. |
| | Saturation | Adjusts the saturation of the screen colors. The lower the value, the less saturated and brighter the colors become. The higher the value, the more saturated and darker the colors become. |
| Reset | Returns color to the default settings. | |

Settings

- 1 To view the **OSD menu**, press the **joystick button** at the bottom of the monitor and then enter the **Menu**.
- 2 Go to **Settings** by moving the joystick.
- 3 Configure the options following the instructions that appear in the bottom right corner.
- 4 To return to the upper menu or set other menu items, move the joystick to ◀ or pressing (⊙ / OK) it.
- 5 If you want to exit the OSD menu, move the joystick to ◀ until you exit.

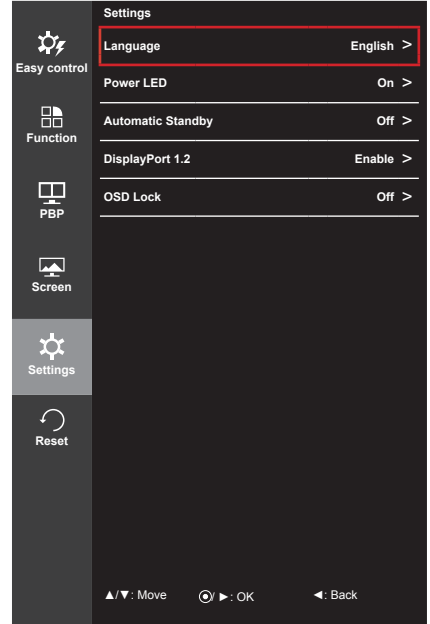

Each option is described below.

| Menu > Settings | Description | |
|--------------------------------------------------------------------------------------------------------------------------------------------------------------------------------------------------------------------------------------------------|-----------------------------------------------------------------------------------------------------------------------------------------------------------------------------------------------------------------------------------------------------------------------------------------------------------------------------------|---------------------------------------|
| Language | Sets the menu screen to the desired language. | |
| Power LED | Turns the power LED on the front of the monitor on or off. | |
| | On | The power LED turns on automatically. |
| | Off | The power LED turns off. |
| Automatic Standby | Feature that automatically turns off the monitor when there is no movement on the screen for a period of time. You can set a timer for the auto-off function. (OFF, 4 hours, 6 hours, and 8 hours) | |
| DisplayPort 1.2 | Enables or disables DisplayPort 1.2. | |
| | <div style="border: 1px solid black; padding: 5px;"> <p>NOTE</p> <ul style="list-style-type: none"> Be sure to configure this option according to the DisplayPort version supported by your graphics card. Set this option to Disable if your graphics card does not support DisplayPort 1.2. </div> | |
| OSD Lock | Prevents incorrect key input. | |
| | On | Disables key input |
| | Off | Enables key input |
| <div style="border: 1px solid black; padding: 5px;"> <p>NOTE</p> <ul style="list-style-type: none"> All features are disabled except Brightness, Contrast, Volume, Input, OSD Lock in Settings and the Exit button. </div> | | |

Reset

- 1 To view the **OSD menu**, press the **joystick button** at the bottom of the monitor and then enter the **Menu**.
- 2 Go to **Reset** by moving the joystick.
- 3 Configure the options following the instructions that appear in the bottom right corner.
- 4 To return to the upper menu or set other menu items, move the joystick to ◀ or pressing (⊙ / OK) it.
- 5 If you want to exit the OSD menu, move the joystick to ◀ until you exit.

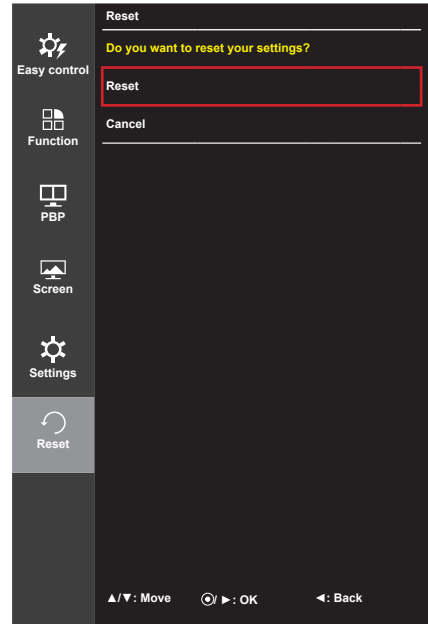

Each option is described below.

| Menu > Reset | Description |
|--------------------------------------------|--------------------------------|
| Do you want to reset your settings? | |
| Reset | Restores the default settings. |
| Cancel | Cancel the reset. |

TROUBLESHOOTING

| Nothing is displayed on the screen. | |
|-----------------------------------------------------|----------------------------------------------------------------------------------------------------------------------------------------------------------------------------------------------------------------------------------------------------------------------------------------------|
| Is the monitor's power cord plugged in? | <ul style="list-style-type: none"> • Check if the power cord is correctly plugged into the power outlet. |
| Is the power LED on? | <ul style="list-style-type: none"> • Check the power cable connection and press the power button. |
| Is the power on and the power LED displaying white? | <ul style="list-style-type: none"> • Check that the connected input is enabled (Menu - Input). |
| Is the power LED blinking? | <ul style="list-style-type: none"> • If the monitor is in power-saving mode, move the mouse, or press any key on the keyboard, to switch the display on. • Check if the computer is turned on. |
| Is the OUT OF RANGE message being displayed? | <ul style="list-style-type: none"> • This occurs when signals transferred from the PC (video card) are out of the horizontal or vertical frequency range of the monitor. Please see the Product Specification section of this manual to set the appropriate frequency. |
| Is the No Signal message being displayed? | <ul style="list-style-type: none"> • This is displayed when the signal cable between the PC and the monitor is missing or disconnected. Check the cable and reconnect it. |

| The 'OSD Lock' message is being displayed. | |
|------------------------------------------------------------------|---------------------------------------------------------------------------------------------------------------------------------|
| Are some functions not available when you press the Menu button? | <ul style="list-style-type: none"> • The OSD is locked. Go to Menu > Settings and set OSD Lock to Off. |

| The screen retains an image. | |
|----------------------------------------------------------------|-------------------------------------------------------------------------------------------------------------------------------------------------------------------------------------------------------------------------------------------------|
| Does image sticking occur even when the monitor is turned off? | <ul style="list-style-type: none"> • Displaying a still image for a prolonged time may cause damage to the screen, resulting in the retention of the image. • To extend the lifetime of the monitor, use a screensaver. |

| Screen display is unstable and shaky / Images displayed on the monitor leave shadow trails. | |
|---------------------------------------------------------------------------------------------|-----------------------------------------------------------------------------------------------------------------------------------------------------------------------------------------------------------------|
| Did you select the appropriate resolution? | <ul style="list-style-type: none"> • If the selected resolution is HDMI 1080i 60/50 Hz (interlaced), the screen may be flickering. Change the resolution to 1080P or the recommended resolution. |



NOTE

- **Vertical Frequency:** In order to display an image, the screen must be refreshed dozens of times per second, like a fluorescent lamp. The number of times the screen is refreshed per second is called vertical frequency, or refresh rate, and is represented by Hz.
- **Horizontal Frequency:** The time it takes to display one horizontal line is called the horizontal cycle. If 1 is divided by the horizontal interval, the result is the number of horizontal lines displayed per second. This is called horizontal frequency and is represented by Hz.

**NOTE**

- Check if the video card's resolution or frequency is within the range allowed by the monitor and set it to the recommended (optimal) resolution in **Control Panel > Display > Settings**.
- Not setting the video card to the recommended (optimal) resolution may result in blurred text, a dimmed screen, a truncated display area or misalignment of the display.
- The setting methods may be different depending on the computer or operating system, and some resolutions may not be available depending on the performance of the video card. If this is the case, contact the manufacturer of the computer or video card for assistance.
- Some video cards may not support 4096 x 2160 / 3840 x 2160 resolution. If the resolution cannot be displayed, contact the manufacturer of your video card.

The display color is abnormal.

| | |
|-------------------------------------------------------|----------------------------------------------------------------------------------------------------------------------------------------------------------------------------------------------------------------------------------------------------------------|
| Does the display appear discolored (16 colors)? | <ul style="list-style-type: none"> • Set the color to 24 bit (true color) or higher. In Windows, go to Control Panel > Display > Settings > Color Quality. |
| Does the display color appear unstable or monochrome? | <ul style="list-style-type: none"> • Check if the signal cable is connected properly. Reconnect the cable or reinsert the PC's video card. |
| Are there spots on the screen? | <ul style="list-style-type: none"> • When using the monitor, pixilated spots (red, green, blue, white or black) may appear on the screen. This is normal for an LCD screen. It is not an error, nor is it related to the monitor's performance. |

No sound from the headphone port.

| | |
|----------------------------------------------------------------------------|---------------------------------------------------------------------------------------------------------------------------------------------------------------------------------------------------------------------------------------------------------------------------------------------------------------------------------------------------------------------------|
| Are images displayed using (Mini) DisplayPort or HDMI input without sound? | <ul style="list-style-type: none"> • Make sure that the headphone port connections are made properly. • Try increasing the volume with the joystick. • Set the audio output of the PC to the monitor you are using: On Microsoft Windows, go to Control Panel > Hardware and Sound > Sound > set the monitor as default device. |
|----------------------------------------------------------------------------|---------------------------------------------------------------------------------------------------------------------------------------------------------------------------------------------------------------------------------------------------------------------------------------------------------------------------------------------------------------------------|

PRODUCT SPECIFICATION

| | | | | |
|--------------------------|-------------------------------------|----------------------------------------------------------------------------------------------------------------------------------------------------------|---------------------|---------|
| LCD Screen | Type | 78.7 cm TFT (Thin Film Transistor) LCD (Liquid Crystal Display) Screen Diagonal length of the screen: 78.7 cm 31" class (31.0" / 78.7 cm diagonal) | | |
| | Pixel Pitch | 0.0567 mm x 0.1701mm | | |
| Resolution | HDMI | Max Resolution | 4096 x 2160 @ 24 Hz | |
| | | Recommended Resolution | 3840 x 2160 @ 30 Hz | |
| | (Mini) DisplayPort | Max Resolution | 4096 x 2160 @ 60 Hz | |
| | | Recommended Resolution | 4096 x 2160 @ 60 Hz | |
| Video Signal | HDMI | Horizontal Frequency | 30 kHz to 90 kHz | |
| | | Vertical Frequency | 56 kHz to 61 kHz | |
| | (Mini) DisplayPort | Horizontal Frequency | 30 kHz to 135 kHz | |
| | | Vertical Frequency | 56 kHz to 61 kHz | |
| | Synchronization | | Separate Sync. | |
| | Input Connector | H/P OUT, HDMI IN 1, HDMI IN 2, mDP (Mini DisplayPort) IN, DP (DisplayPort) IN, USB UP, USB IN 1, 2, 3 | | |
| Power Sources | Vltage | AC 100-240 V~ 50 / 60 Hz | | |
| | Power Consumption (Typical) | Operating Mode: 49 W (Typical, USB excluded, Audio Output 20%) 85 W (Max, USB included, Audio Output 50%) Power Saving Mode ≤ 1.2 W | | |
| | | Off Mode | Power Button | ≤ 0.5 W |
| | | Switch | 0 W | |
| Stand Angle | Forward/Backward: -5° to 15° (Head) | | | |
| Environmental Conditions | Operating Conditions | Temperature: 10°C to 35°C Humidity: 10% to 80% | | |
| | Storing Conditions | Temperature: -20°C to 60°C Humidity: 5% to 90% | | |
| Audio Output | 5 W + 5 W | | | |

| | | |
|----------------------------|---------------------------------------|--------|
| Dimensions | Monitor Size (Width x Height x Depth) | |
| | 736.7 mm x 483.5 mm x 241.4 mm | |
| Weight (Without Packaging) | With Stand | 9.6 kg |
| | Without Stand | 7.7 kg |

Specifications are subject to change without notice.

Factory Support Mode (Preset Mode, HDMI/(Mini) DisplayPort PC)

| Preset Mode | Horizontal Frequency (kHz) | Vertical Frequency (Hz) | Polarity (H/V) | Remarks |
|-------------|----------------------------|-------------------------|----------------|--------------------------------------------------------|
| 640 x 480 | 31.469 | 59.94 | -/- | |
| 800 x 600 | 37.879 | 60.317 | +/+ | |
| 1024 x 768 | 48.363 | 60 | -/- | |
| 1280 x 720 | 45 | 60 | +/+ | |
| 1280 x 1024 | 63.981 | 60.02 | +/+ | |
| 1600 x 900 | 60 | 60 | +/+ | |
| 1920 x 1080 | 67.5 | 60 | +/- | |
| 2048 x 2160 | 133.32 | 60 | +/- | Recommended resolution for HDMI/(Mini) DisplayPort PBP |
| 3840 x 2160 | 133.32 | 60 | +/- | HDMI is not supported. |
| 3840 x 2160 | 67.5 | 30 | +/- | (Mini) DisplayPort is not supported. |
| 4096 x 2160 | 133.32 | 60 | +/- | HDMI is not supported. |
| 4096 x 2160 | 54 | 24 | +/- | (Mini) DisplayPort is not supported. |

HDMI Timing (Video)

| Preset Mode | Horizontal Frequency (kHz) | Vertical Frequency (Hz) | Remarks |
|-------------|----------------------------|-------------------------|---------|
| 480P | 31.5 | 60 | |
| 720P | 45 | 60 | |
| 1080P | 67.5 | 60 | |

Power LED

| Mode | LED Color |
|-------------------|----------------|
| On Mode | White |
| Power Saving Mode | Flashing White |
| Off Mode | Off |

PROPER POSTURE

Proper Posture for Using the Monitor

Adjust the screen so that you can comfortably look at it at a slight downward angle from your natural eye level.

- Take a break for approximately 10 minutes every hour to reduce any fatigue caused by prolonged usage.
- The stand of the touch monitor allows the product to be used in the optimum position.
- Adjust the stand angle from -5° to 15° to obtain the best view of the screen.

You should be looking slightly down at the screen.

Stand Angle
 -5° to 15°

Adjust the position of the screen to minimize reflections.

Place your hands gently on the keyboard, keeping your arms bent at the elbows and extended horizontally in front of you.

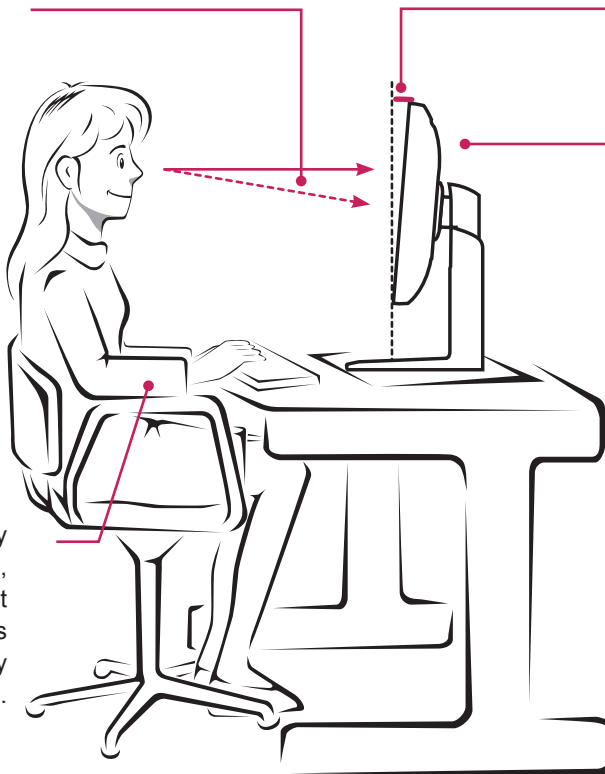



Declaration of Conformity

Trade Name: LG
Model: 31MU97
Responsible Party: LG Electronics Inc.
Address: 1000 Sylvan Ave.
Englewood Cliffs NJ 07632
U.S.A
TEL: 201-266-2534

This device meets the EMC requirements for home appliances (Class B) and is intended for home usage. This device can be used in all regions. Read the owner's manual (CD) carefully and keep it at hand. Please note that the label attached to the product provides information for technical support.

Model _____

Serial No. _____

ENERGY STAR is a set of power-saving guidelines issued by the U.S. Environmental Protection Agency (EPA).



As an ENERGY STAR Partner LGE U. S. A., Inc. has determined that this product meets the ENERGY STAR guidelines for energy efficiency.

Refer to ENERGY STAR.gov for more information on the ENERGY STAR program.